

Features & Benefits

- Single-Phase Universal AC input+9
- Rugged Unit for Military Applications
- 91% Efficiency at Full Load
- Wide Input Voltage Range
- Built-in Active PFC Function
- Internal ORing Diode
- Multiple Units in a Redundant or Parallel System
- Droop Current Sharing
- IP67 Sealed
- RS485 Communication
- Temperature Sensor
- Power Good Signal
- Input Under Voltage Protection
- Input/Output Over Voltage Protection
- Input Over Current Protection
- Short Circuit Protection
- Over Temperature Protection
- Two Units can be Mounted in 2U Height 19" Rack
- On/Off Switch
- LED Indicators
- Grounding Interface
- Forced Air Cooled

Compliance

Module is designed to meet:

- MIL-STD-461G
- MIL-STD-810G
- MIL-STD-1275E
- EN IEC 62368-1:2023
- EN 55011 / EN 55032
- EN 61000-3-x
- EN 61000-4-x

For details, see page Compliance.

Typical Applications

- Military/Defense Power Systems
- Armored Vehicles
- Land Platforms
- Communications and Radar Systems

Product Ratings	
V_{IN}	90–265 V_{RMS} (Single-Phase)
V_{IN_NOM}	220 V_{RMS}
V_{OUT}	28 V_{DC}
I_{OUT}	100 A
P_{OUT}	2800 W

Product Description

Power Supply is an advanced single-phase AC-DC power supply unit with active PFC function. It operates in constant current (CC) and constant voltage (CV) modes effectively, providing best-in-class regulation and dynamic performance.

The unit is designed to guarantee high performance under extreme environmental conditions with superior protection features against external faults and disturbances while meeting the major military standards. KOLT's innovative engineering has enabled a compact design of the converter with high efficiency.



Size: 530.00 x 215.90 x 87.75 mm
(19" / 2 form factor, 2U height)

Weight: 13 ± 0.5 kg

Electrical Characteristics

Input Characteristics					
Parameters	Notes & Conditions	Min	Typ	Max	Unit
Input Voltage		90	220	265	V _{RMS}
Input Voltage (non-working)	Withstanding input voltage	-	-	300	V _{RMS}
Input Frequency		47	50	63	Hz
Input Current THD	From half load to full load, nominal input voltage	6	-	10	%
No Load Input Power	Nominal input voltage	-	-	50	W
Inrush Current (peak)	Nominal input voltage	-	-	±40	A
Leakage Current to Ground	10% load, nominal input voltage	-	-	5	mA _{RMS}
AC Input Quiescent Current	When input switch is OFF	-	-	200	mA _{RMS}

Output Characteristics					
Parameters	Notes & Conditions	Min	Typ	Max	Unit
Output Voltage		-	28	-	V
Output Current		-	-	100	A
Output Power	Subject to derating per input voltage (see Figure 17)	-	-	2800	W
Output Ripple and Noise (pk-pk)	20 MHz Bandwidth	-	-	400	mV
Line Regulation	Over the full range of line input voltage	-	±0.1	-	V
Load Regulation	From 10% load to full load, nominal input voltage	-	±0.1	-	V

General Characteristics					
Parameters	Notes & Conditions	Min	Typ	Max	Unit
Efficiency	From half load to full load, nominal input voltage	90	-	91	%
Power Factor	From half load to full load, nominal input voltage	0.97	-	0.99	-
Soft-Start Time		-	1	-	s
Hold-up Time		10	15	-	ms
Weight		-	-	13	kg
Cooling	Forced air by temperature-controlled fans				
Built-in Test Feature	DC OK, Remote Error Sensing				

Protections					
Parameters	Notes & Conditions	Min	Typ	Max	Unit
Input Under Voltage Protection	When the voltage returns within the normal limits, unit resumes operation automatically	80	85	90	V _{RMS}
Input Over Voltage Protection		265	270	275	V _{RMS}
Output Over Current Protection	Fully electronic against over-load	-	130	-	A
Output Over Voltage Protection	-	-	32.4	-	V
Input Over Current Protection	Auto-retry				
Output Short Circuit Protection	Fully electronic against over-load and continuous short-circuit conditions				
Over Temperature Protection	Automatically resumes operation when temperature decreases				

Isolation Characteristics					
Parameters	Notes & Conditions	Min	Typ	Max	Unit
Insulation Resistance	Input to Case	-	>100	-	MΩ
	Output to Case	-	>100	-	MΩ
Isolation Voltage	Input to Output	-	-	500	V _{DC}
	Input to Case	-	-	500	V _{DC}
	Output to Case	-	-	500	V _{DC}

Environmental Characteristics						
Parameters	Standard	Min	Typ	Max	Unit	Status
Operational Temperature	MIL-STD-810G_CHG-1 Method 501.6/502.6 Procedure II	-32	-	+50	°C	Passed
Storage / Transport Temperature	MIL-STD-810G_CHG-1 Method 501.6/502.6 Procedure I	-40	-	+63	°C	Passed
Operational Low Pressure	MIL-STD-810G_CHG-1 Method 500.6 Procedure II	-	-	3000	m	Similarity*
Storage / Transport Low Pressure	MIL-STD-810G_CHG-1 Method 500.6 Procedure I	-	-	4500	m	Designed to Meet
Parameters	Standard	Waveform	Peak Value	Pulse Duration	Axis	Status
Shock	MIL-STD-810G_CHG-1 Method 516.7 Procedure I	Sawtooth	20g	11 ms	±X, ±Y, ±Z	Similarity*
		Half-Sine	10g	11 ms	±X, ±Y, ±Z	Similarity*
Parameters	Standard	Category	Figure	Platform	Vehicle	Status
Vibration	MIL-STD-810G_CHG-1 Method 514.7 Procedure I	Category 4	514.7C-2	Secured Cargo	Truck Transportation and Composite Wheeled Vehicles	Similarity*
		Category 8	514.7C-8	Aircraft	Propeller	Similarity*
		Category 11	514.7C-11	Railroad	Train	Similarity*
		Category 20	514.7C-4	Ground	Wheeled Vehicles	Similarity*
		Category 21	514.7D-9	Watercraft	Marine Vehicles	Similarity*
Parameters	Standard	Condition				Status
Salt Fog	MIL-STD-810G_CHG-1 Method 509.6	24 hours spray, 24 hours dry, applied 2 times				Designed to Meet
Sand and Dust	MIL-STD-810G_CHG-1 Method 510.6 Procedure I/II	<150 µm Dust 150-850 µm Sand				Similarity*
Fungus	MIL-STD-810G_CHG-1 Method 508.7	Analysis of the degree of inertness to fungus growth of the components.				Analysis
Solar Radiation	MIL-STD-810G_CHG-1 Method 505.6 Procedure I	A2				Designed to Meet
Humidity	MIL-STD-810G_CHG-1 Method 507.6 Procedure II	≥ %95 Relative @30°C				Similarity*
Impermeability	IP67	Tested by immersion in 1 m water for 30 minutes				Passed
Parameters	Standard	Test				Status
EMI/EMC	MIL-STD-461G Ground Army	CE102	CS101 CS114 CS115 CS116 CS118	RE102	RS103	Similarity*

* Verified on similar unit. Both units consist of identical converter modules.

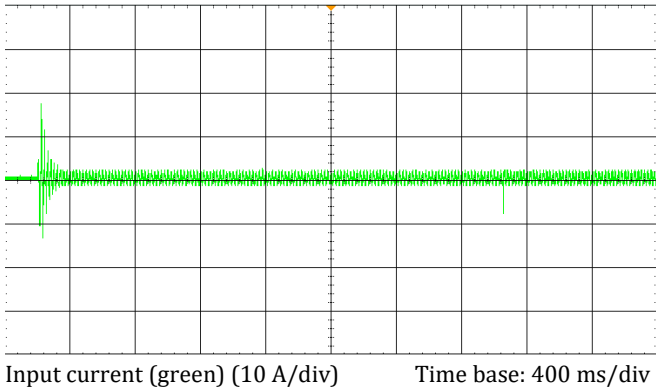

Figure 1. Inrush current at nominal input voltage

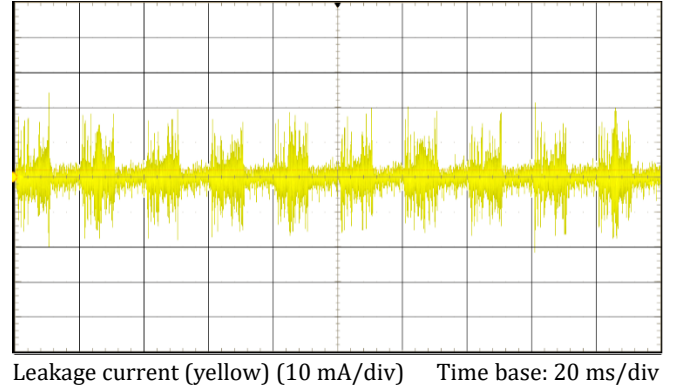

Figure 4. Leakage current to ground at nominal input voltage and 10% load current

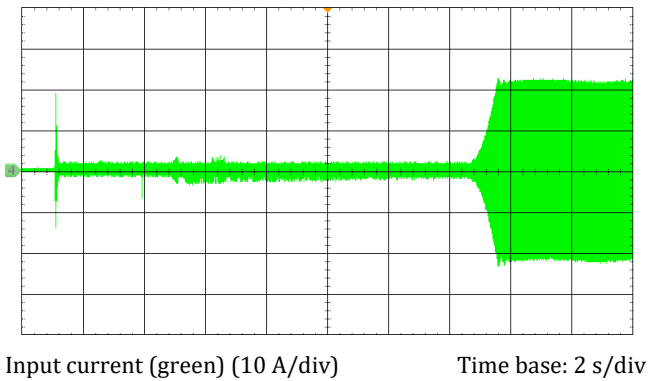

Figure 2. Input current for inrush and start-up stages at nominal input voltage

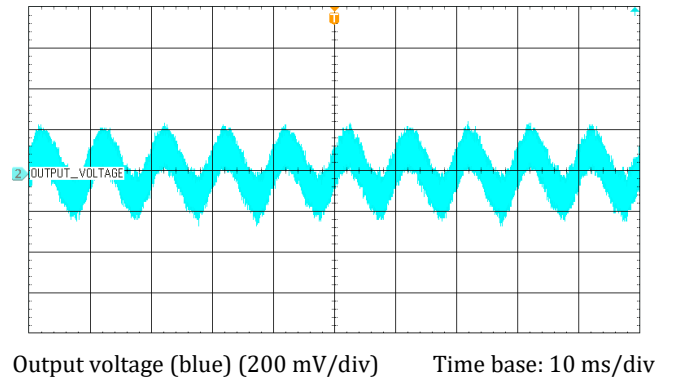

Figure 5. Output voltage ripple at nominal input voltage and rated load current (AC Coupled), Bandwidth: 20 MHz

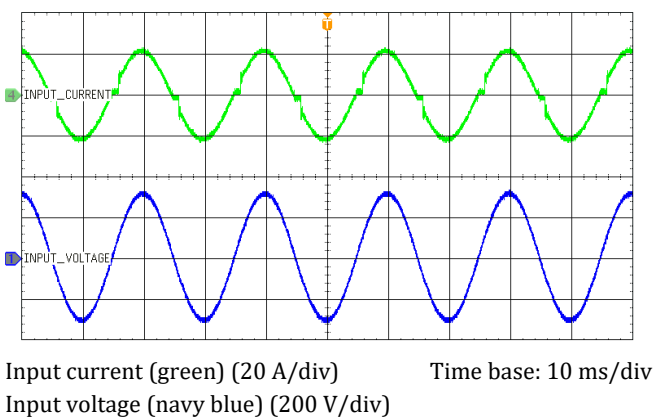

Figure 3. Typical input voltage and current waveforms at rated load current

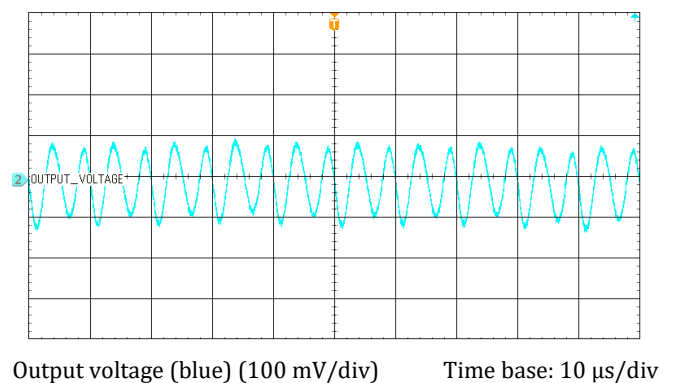
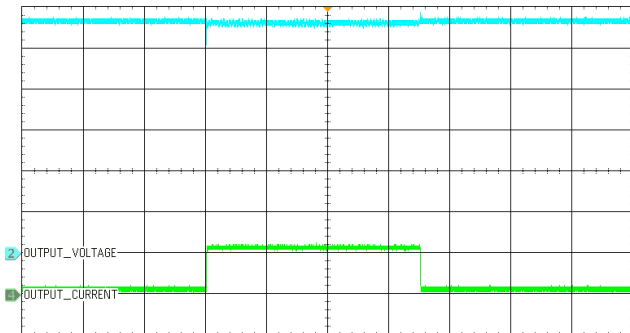
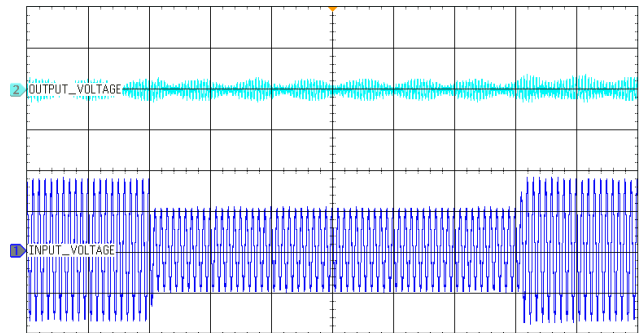

Figure 6. Zoomed in view of output voltage ripple at nominal input voltage and rated load current (AC Coupled), Bandwidth: 20 MHz



Output voltage (blue) (5 V/div) Time base: 200 ms/div
Output current (green) (100 A/div)

Figure 7. Load transient response: from 10% to 100% and back to 10% at nominal output voltage (DC Coupled)



Output voltage (blue) (1 V/div) Time base: 200 ms/div
Input voltage (navy blue) (200 V/div)

Figure 10. Zoomed in view of line transient response: from 265 V_{RMS} to 135 V_{RMS} and back to 265 V_{RMS} at nominal output voltage (AC Coupled)

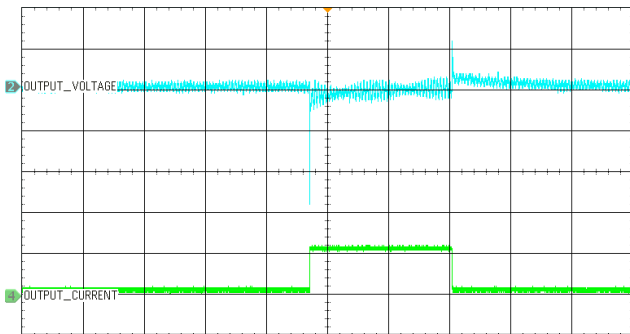

Output voltage (blue) (1 V/div) Time base: 100 ms/div
Output current (green) (100 A/div)

Figure 8. Zoomed in view of load transient response: from 10% to 100% and back to 10% at nominal output voltage (AC Coupled)

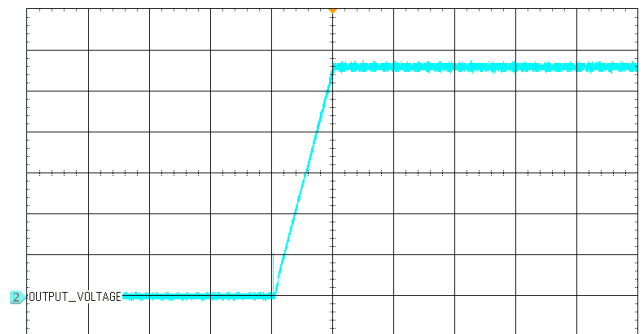

Output voltage (blue) (5 V/div) Time base: 1 s/div

Figure 11. Start-up waveform at rated load current and nominal output voltage

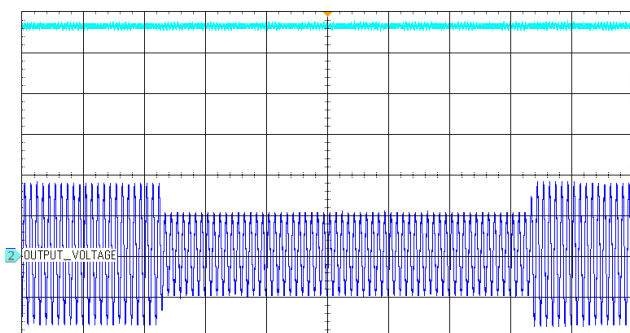

Output voltage (blue) (5 V/div) Time base: 200 ms/div
Input voltage (navy blue) (200 V/div)

Figure 9. Line transient response: from 265 V_{RMS} to 135 V_{RMS} and back to 265 V_{RMS} at nominal output voltage (DC Coupled)

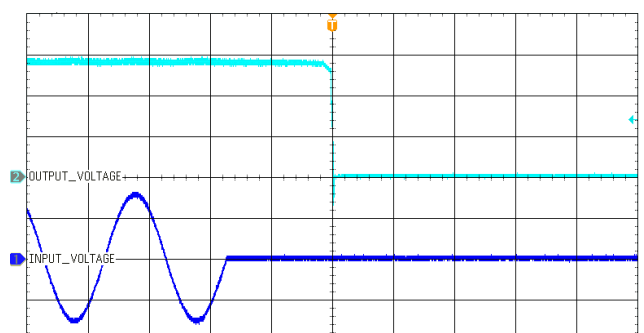

Output voltage (blue) (10 V/div) Time base: 10 ms/div
Input voltage (navy blue) (200 V/div)

Figure 12. Hold-up waveform at rated load current and nominal output voltage

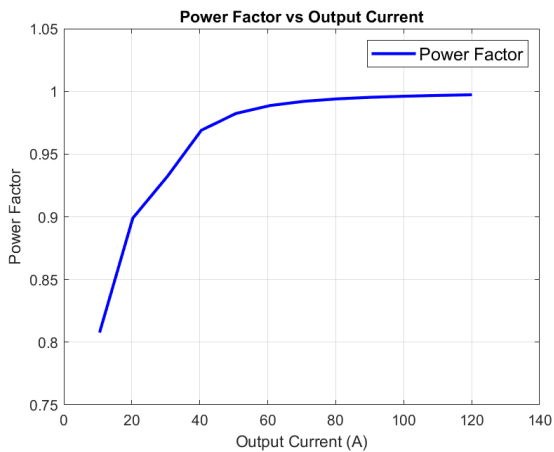

Figure 13. Power factor versus output current at nominal input voltage

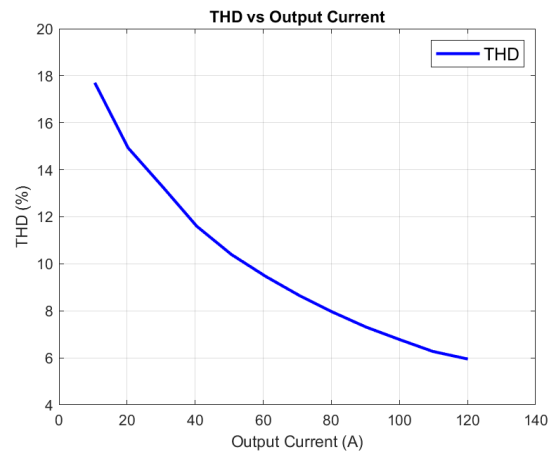

Figure 16. Total harmonic distortion (THD) versus output current at nominal input voltage

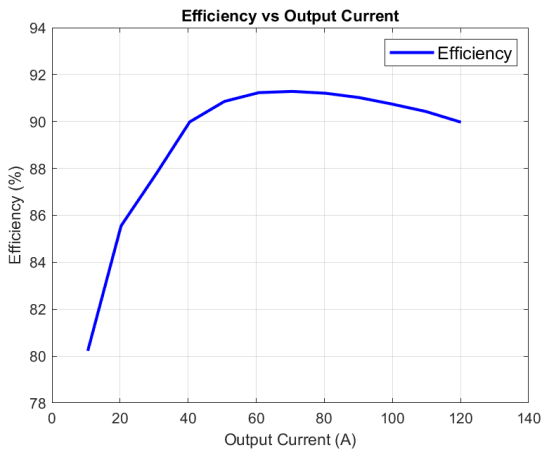

Figure 14. Efficiency versus output current at nominal input voltage

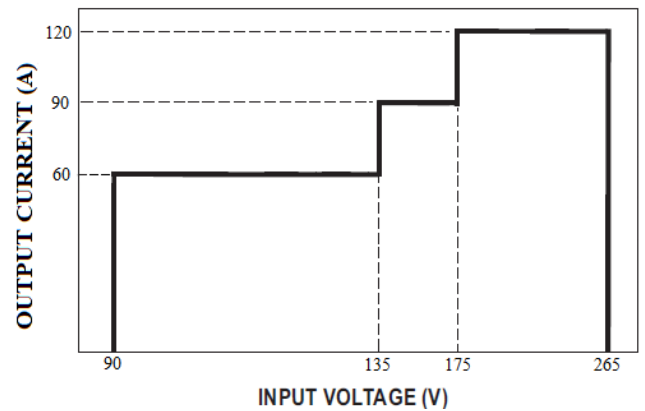

Figure 17. Derating curve of output load versus input voltage

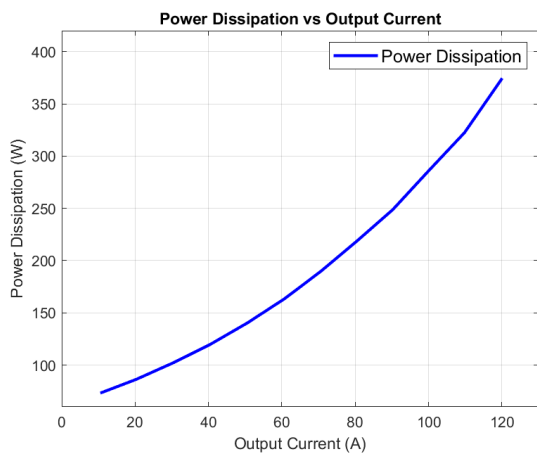

Figure 15. Power dissipation versus output current at nominal input voltage

Connector Configuration



Figure 18. Connector Panel

AC Input Connector (KN1)

Part Numbers (interchangeable):

- Amphenol 97B-4102E-16S-1P
- ITT Cannon CA3102E16S-1P-B-F80

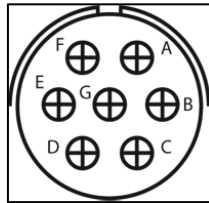

Figure 19. Input Connector View

Pin	Signal Name	Function
A	PHASE	AC Line Input (PHASE)
B	PHASE	AC Line Input (PHASE)
C	PHASE	AC Line Input (PHASE)
D	NEUTRAL	AC Line Input (NEUTRAL)
E	NEUTRAL	AC Line Input (NEUTRAL)
F	NEUTRAL	AC Line Input (NEUTRAL)
G	CHASSIS	AC Line Input (EARTH)

DC Output Connector (KN2)

Part Numbers (interchangeable):

- Amphenol 97B-4102E-32-17S
- ITT Cannon CA3102E32-17S-B-F80

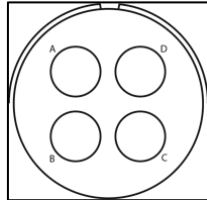

Figure 20. Output Connector View

Pin	Signal Name	Function
A	OUT	DC Output
B	OUT	DC Output
C	OUT_RTN	DC Output Return
D	OUT_RTN	DC Output Return

Signal Connector #1 (KN3)

Part Numbers:

- D38999/20WB35SN

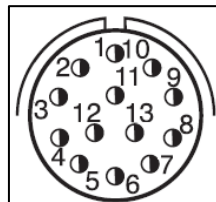

Figure 21. Signal Connector View

Pin	Signal Name	Function
1	DATA+	Factory service input
2	DATA-	Factory service input
3	DATA_RTN	Factory service return signal
4	-	-
5	ID0	Identification input
6	ID1	Identification input
7	ID2	Identification input
8	ID3	Identification input
9	ID_RTN	Identification return signal
10	-	-
11	CS_DATA+	Current share input
12	CS_DATA-	Current share input
13	CS_DATA_RTN	Current share return signal

Signal Connector #2 (KN4)

Part Numbers:

- D38999/20WB35SA

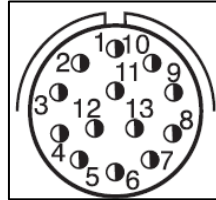

Figure 22. Signal Connector View

Pin	Signal Name	Function
1	DATA+	Factory service input
2	DATA-	Factory service input
3	DATA_RTN	Factory service return signal
4	-	-
5	NTC	Temperature sensor
6	NTC_RTN	Temperature sensor return signal
7	PGOOD	Power good signal
8	PGOOD_RTN	Power good return signal
9	-	-
10	-	-
11	CS_DATA+	Current share input
12	CS_DATA-	Current share input
13	CS_DATA_RTN	Current share return signal

LED Configuration

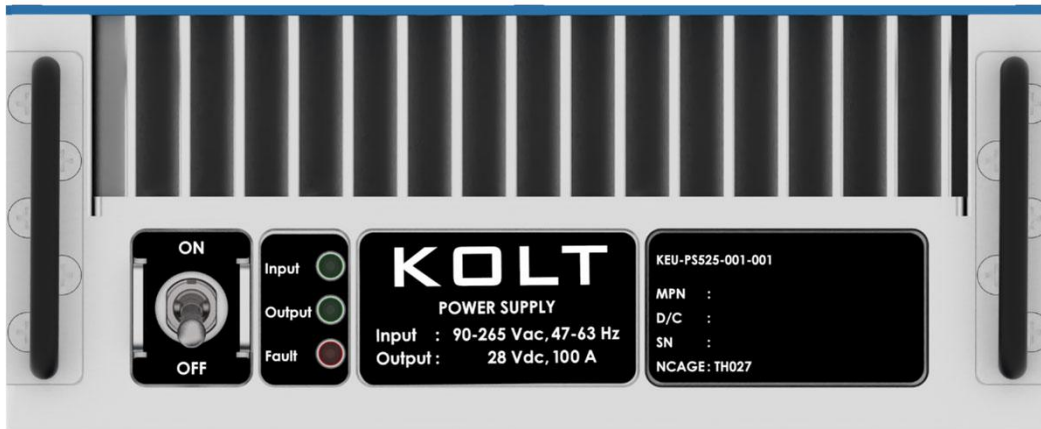

Figure 23. Front Panel

LED Name	Status	Description	Function
Input	Off	AC Input Passive	AC input is below 70 V _{RMS}
	Green	AC Input Active	AC input voltage is within the operating limit (90-265 V _{RMS})
	Red	AC Input Fault	<ul style="list-style-type: none"> Input Under Voltage / Over Voltage Input Over Current Line Frequency not within limits

LED Name	Status	Description	Function
Output	Off	DC Output Passive	DC output is not active
	Green	DC Output Active	DC output is within the defined limits
	Red	DC Output Fault	<ul style="list-style-type: none"> Output Over Voltage / Short Circuit Output Regulation Error

LED Name	Status	Description	Function
Fault	Off	Device OK	No fault is present
	Red	Device Fault	<ul style="list-style-type: none"> Mid-Bus Over Voltage Temperature Critical Fault

Label Configuration



Figure 24. Turkish Label Option Front View



Figure 25. Turkish Label Option Back View



Figure 26. English Label Option Front View



Figure 27. English Label Option Back View

Mechanical Drawings

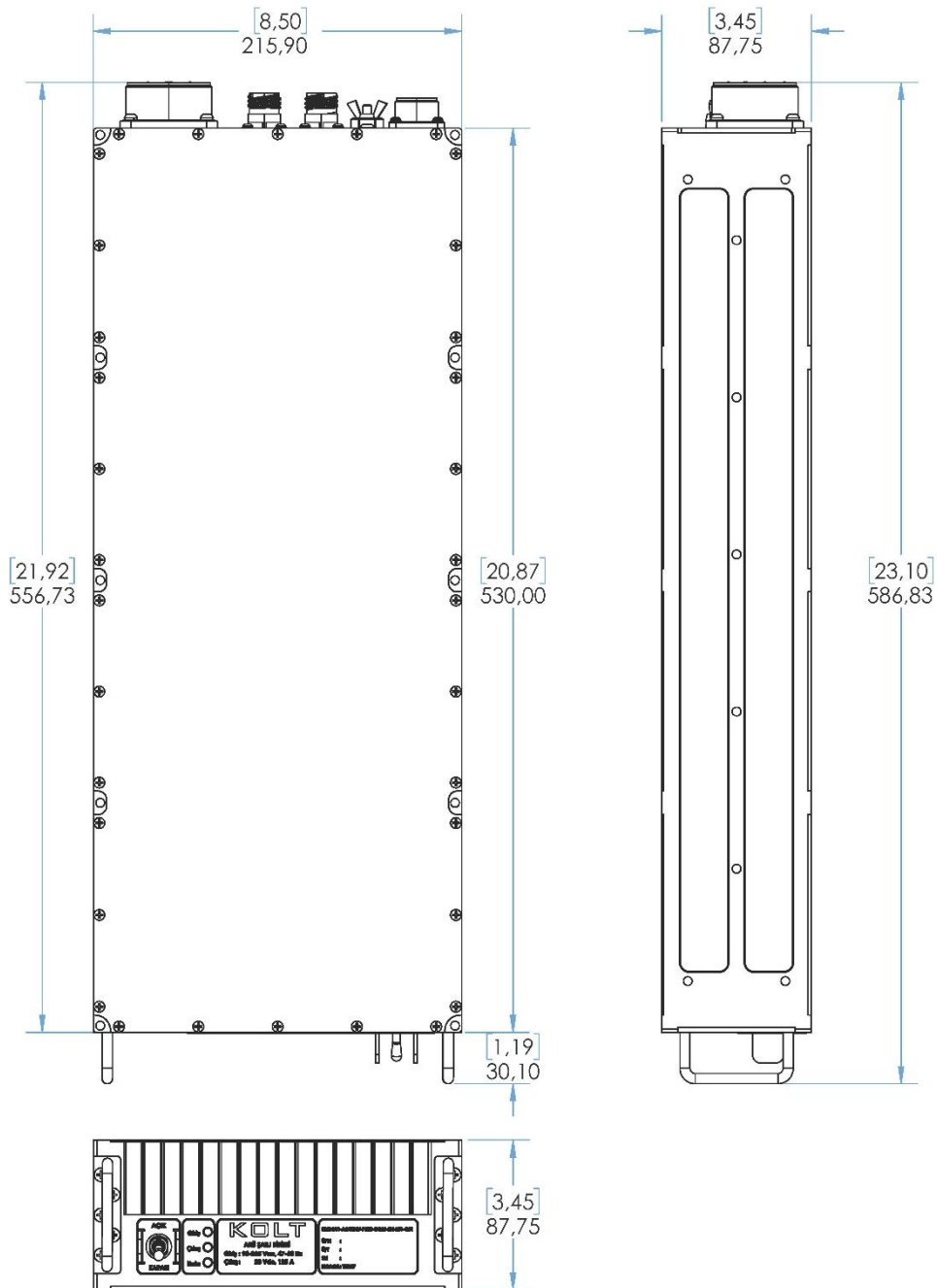

Figure 28. Mechanical Dimensions

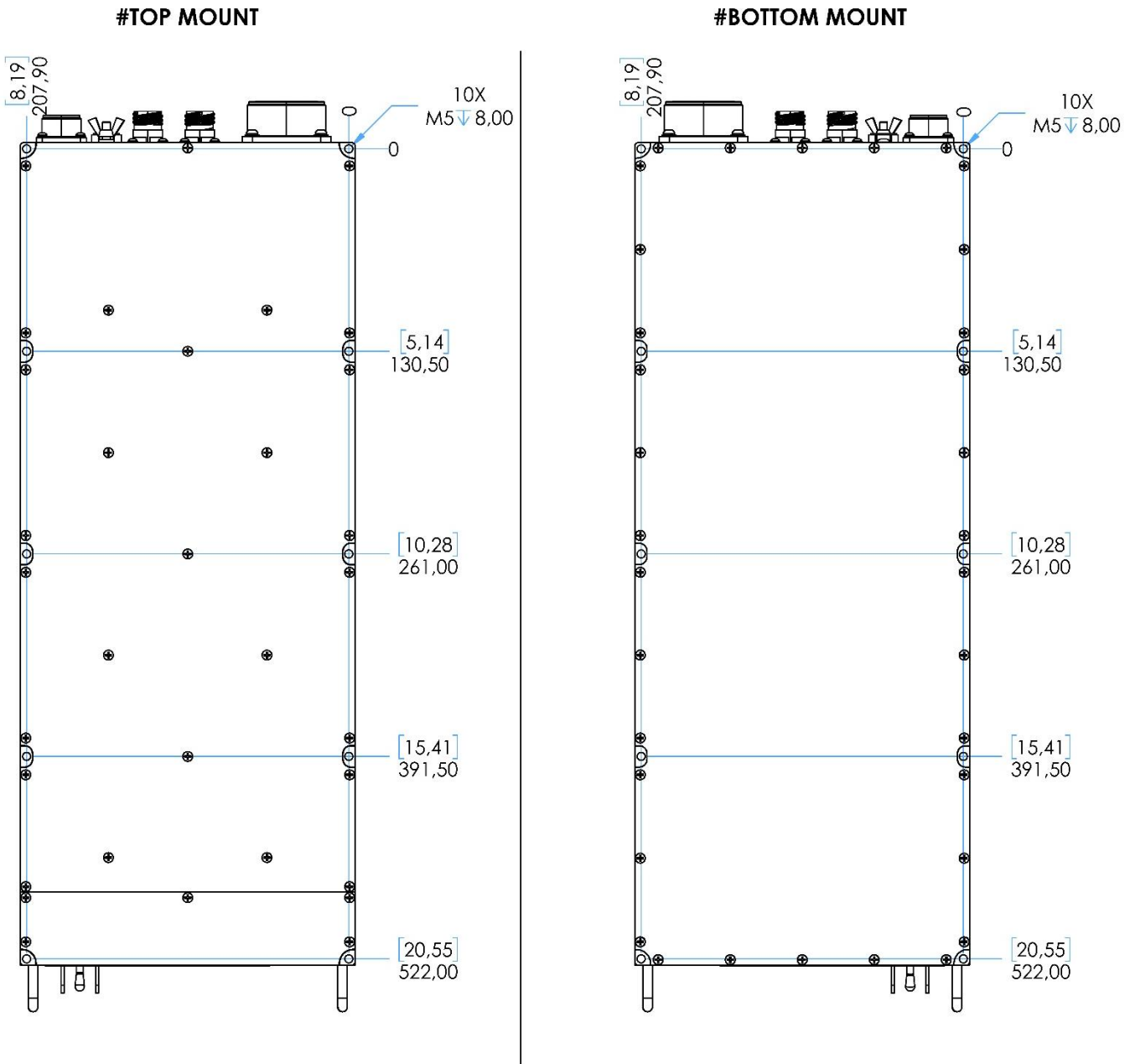

Figure 29. Mounting Details and Mounting Holes Coordinates

Material: Aluminum Alloy 6061-T6

Size: 530.00 x 215.90 x 87.75 mm
(19"/2 form factor, 2U height)

Weight: 13 ± 0.5 kg

Dimensions are in millimeters [inches].

Compliance

Safety (LVD)

- EN IEC 62368-1:2023 (Audio/video, information and communication technology equipment – Safety requirements)
- Class I equipment, protective earth required

For use only in or with complete equipment. The acceptability of the final combination is the responsibility of the manufacturer of the end product.

EMC

Emissions

- EN 55011 / EN 55032 – Conducted and radiated emissions, Class A, industrial environment
- EN 61000-3-2 – Harmonic current emissions, Class A
- EN 61000-3-3 – Voltage fluctuations and flicker

Immunity

- EN 61000-4-2 – ESD immunity
- EN 61000-4-3 – Radiated RF immunity
- EN 61000-4-4 – EFT/Burst immunity
- EN 61000-4-5 – Surge immunity
- EN 61000-4-6 – Conducted RF immunity
- EN 61000-4-8 – Power-frequency magnetic field immunity
- EN 61000-4-11 – Voltage dips and interruptions

Part Ordering Information

Family	Product Variant	Option Variant	Compliance
KEU-PS525	001	-	R: RoHS & REACH

Ordering Number	Color Option	Label Option	RoHS (Note*)
KEU-PS525-001-001	Blue Anodized Coated / MIL-C-5541E White Alodine	Turkish	RoHS 5/6 (Pb above limit)*
KEU-PS525-001-002	RAL 6014 Yellow Olive	Turkish	RoHS 5/6 (Pb above limit)*
KEU-PS525-001-003	RAL 9005 Jet Black	Turkish	RoHS 5/6 (Pb above limit)*
KEU-PS525-001-004	FED-STD-595C 34094 Green 383 Camouflage	Turkish	RoHS 5/6 (Pb above limit)*
KEU-PS525-001-005	FED-STD-595C 37030 Black Camouflage	Turkish	RoHS 5/6 (Pb above limit)*
KEU-PS525-001-006	RAL 9016 Traffic White	Turkish	RoHS 5/6 (Pb above limit)*
KEU-PS525-001-007	RAL 7001 Silver Grey	Turkish	RoHS 5/6 (Pb above limit)*
KEU-PS525-001-008	FED-STD-595C 30315 Desert Sand Camouflage	Turkish	RoHS 5/6 (Pb above limit)*
KEU-PS525-001-009	FED-STD-595C 33245 Earth Yellow Camouflage	Turkish	RoHS 5/6 (Pb above limit)*
KEU-PS525-001-010	Blue Anodized Coated / MIL-C-5541E White Alodine	English	RoHS 5/6 (Pb above limit)*
KEU-PS525-001-011	RAL 6014 Yellow Olive	English	RoHS 5/6 (Pb above limit)*
KEU-PS525-001-012	RAL 9005 Jet Black	English	RoHS 5/6 (Pb above limit)*
KEU-PS525-001-013	FED-STD-595C 34094 Green 383 Camouflage	English	RoHS 5/6 (Pb above limit)*
KEU-PS525-001-014	FED-STD-595C 37030 Black Camouflage	English	RoHS 5/6 (Pb above limit)*
KEU-PS525-001-015	RAL 9016 Traffic White	English	RoHS 5/6 (Pb above limit)*
KEU-PS525-001-016	RAL 7001 Silver Grey	English	RoHS 5/6 (Pb above limit)*
KEU-PS525-001-017	FED-STD-595C 30315 Desert Sand Camouflage	English	RoHS 5/6 (Pb above limit)*
KEU-PS525-001-018	FED-STD-595C 33245 Earth Yellow Camouflage	English	RoHS 5/6 (Pb above limit)*
KEU-PS525-001-001R	Blue Anodized Coated / MIL-C-5541E White Alodine	Turkish	RoHS-3 & REACH compliant
KEU-PS525-001-002R	RAL 6014 Yellow Olive	Turkish	RoHS-3 & REACH compliant
KEU-PS525-001-003R	RAL 9005 Jet Black	Turkish	RoHS-3 & REACH compliant
KEU-PS525-001-004R	FED-STD-595C 34094 Green 383 Camouflage	Turkish	RoHS-3 & REACH compliant
KEU-PS525-001-005R	FED-STD-595C 37030 Black Camouflage	Turkish	RoHS-3 & REACH compliant
KEU-PS525-001-006R	RAL 9016 Traffic White	Turkish	RoHS-3 & REACH compliant
KEU-PS525-001-007R	RAL 7001 Silver Grey	Turkish	RoHS-3 & REACH compliant
KEU-PS525-001-008R	FED-STD-595C 30315 Desert Sand Camouflage	Turkish	RoHS-3 & REACH compliant
KEU-PS525-001-009R	FED-STD-595C 33245 Earth Yellow Camouflage	Turkish	RoHS-3 & REACH compliant
KEU-PS525-001-010R	Blue Anodized Coated / MIL-C-5541E White Alodine	English	RoHS-3 & REACH compliant
KEU-PS525-001-011R	RAL 6014 Yellow Olive	English	RoHS-3 & REACH compliant
KEU-PS525-001-012R	RAL 9005 Jet Black	English	RoHS-3 & REACH compliant
KEU-PS525-001-013R	FED-STD-595C 34094 Green 383 Camouflage	English	RoHS-3 & REACH compliant
KEU-PS525-001-014R	FED-STD-595C 37030 Black Camouflage	English	RoHS-3 & REACH compliant
KEU-PS525-001-015R	RAL 9016 Traffic White	English	RoHS-3 & REACH compliant
KEU-PS525-001-016R	RAL 7001 Silver Grey	English	RoHS-3 & REACH compliant
KEU-PS525-001-017R	FED-STD-595C 30315 Desert Sand Camouflage	English	RoHS-3 & REACH compliant
KEU-PS525-001-018R	FED-STD-595C 33245 Earth Yellow Camouflage	English	RoHS-3 & REACH compliant

RoHS & REACH Compliance*

By default, KOLT products are manufactured using SnPb solder for high-reliability applications and therefore are **not** compliant with EU RoHS Directive 2011/65/EU (as amended by (EU) 2015/863). These products meet RoHS requirements for all substances except lead (Pb). **These products are NOT CE marked due to SnPb solder.**

A **lead-free** build that meets RoHS-3 requirements and is designed to be REACH compliant is available by adding the “-R” suffix to the part number. **Only these products are CE marked.**

Revision History

Document Number	Revision	Date	Description	Page Number(s)
109398	01	08.10.2024	Initial Release	-
109398	02	22.03.2025	Second Release	-
109398	03	05.08.2025	Part Number updated.	-
109398	04	02.12.2025	CE marking updated.	-

Contact Us

KOLT Türkiye

salesturkiye@koltpower.com

KOLT Muhendislik A.S.

Saray OSB, G2 Cd. No:9
Kahramankazan, Ankara 06980

Türkiye

www.kolt.com.tr**KOLT Europe**

saleseurope@koltpower.com

KOLT Power Ltd.

Fareham Innovation Centre, Merlin House, 4 Meteor Way,
Daedalus Drive, Lee-On-Solent, Fareham, PO13 9FU

United Kingdom

www.koltpower.com

The information provided in this datasheet is believed to be accurate and reliable. However, KOLT assumes no responsibility for any consequences arising from its use, nor for any infringement of patents or other rights of third parties that may result from its use. These products are sold only under KOLT's general terms and conditions of sale, unless otherwise specified in writing. Specifications are subject to change without notice. All rights reserved.