

Features & Benefits

- Rugged Unit for Military Applications
- Switchable Modes: Power Supply & Battery Charger
- High Efficiency, High Power Density
- Wide Input Voltage Range
- Built-in Active PFC Function
- Programmable Output Voltage and Current
- Charger for Lead-Acid Batteries (Flooded, GEL and AGM) and Li-Ion Batteries (Lithium Iron and Lithium Manganese)
- Droop Current Sharing & Internal ORing Diode
- Two Units in a Redundant or Parallel System
- IP67 Sealed
- RS-485 Communication
- Input Under Voltage Protection
- Input/Output Over Voltage Protection
- Short Circuit Protection
- Over Temperature Protection
- Reverse Battery Protection
- Stand Alone or Two Unit Mounted in 19" Rack
- LCD Display
- LED Indicators
- Grounding Interface

Compliance

Module is designed to meet:

- MIL-STD-1399B
- MIL-STD-461G
- MIL-STD-810G

Typical Applications

- Military/Defense Power Supplies
- Armored Vehicles
- Land Platforms
- Communications and Radar Systems

Product Ratings	
$V_{IN} = 90-265 V_{RMS}$	$V_{OUT_NOM} = 28 V_{DC}$
$V_{IN_NOM} = 220 V_{RMS}$ SINGLE PHASE	$I_{OUT_NOM} = 90 A_{DC}$ $P_{OUT_NOM} = 2500 W$

Product Description

KMBC02 is a high efficiency and rugged multifunction AC-DC converter that offers operation in dual modes: power supply and battery charger modes. Mode selection can be done remotely or locally via front panel. As a power supply, it regulates a constant voltage with a programmable current limit. In battery charger mode, converter regulates a constant current according to the charging characteristics of the selected battery technology. Unit is designed to guarantee high performance in both modes under extreme environmental conditions. It has superior protection features against external faults and disturbances while meeting the major military standards. KOLT's innovative engineering has enabled a compact design of the converter with high power density and performance. This unit is factory configurable both electrically and mechanically to best fit the application.



Size: 480 × 220 × 88 mm

Electrical Characteristics

Parameters	Comments	Min	Typ.	Max	Unit
Input Characteristics					
Input Voltage	Universal	90	220	265	V _{RMS}
Input Frequency	Universal	47	50	63	Hz
Input Current THD	@Rated output power	-	-	10%	-
Input No Load Current	@Nominal input voltage	-	0.63	-	A
Inrush Current	@Nominal input voltage	-	-	±40	A
Leakage Current	@10% load, nominal input voltage	-	2	5	mA _{RMS}
Output Characteristics					
Output Voltage	User settable	18	28	30	V
Output Current	User settable	-	90	100	A
Output Power	Subject to derating (see Figure 3)	-	2500	3000	W
Output Ripple and Noise (pk-pk)	@20 MHz Bandwidth	-	-	400	mV
Line Regulation	Over the full range of line input voltage	Insignificantly small			-
Load Regulation	From 10% load to full load, nominal input voltage	-	100	-	mV
External Load Capacitance		-	-	TBD	μF
General Characteristics					
Efficiency	@Rated output power	90%	-	-	-
Power Factor	@Rated output power	99%	-	-	-
Turn-on Delay	Health Check	-	-	500	ms
Soft-Start Time		-	-	1	s
Hold-up Time		10	-	-	ms
Power Density	@Rated output power	-	269	323	W/dm ³
Weight		-	-	13	kg
Length	Connectors and handle lengths are not included	-	-	480	mm
Depth		-	-	220	mm
Height		-	-	88	mm
Cooling	Forced air by temperature controlled fans				
Built-in Test Feature	DC OK, Remote Error Sensing				

Protections					
Input Circuit Breaker	The input circuit breaker is for fault protection and is also used as an ON/OFF switch				
Input Under Voltage Protection	When the voltage returns within the normal limits, unit resumes operation automatically	80	85	90	V _{RMS}
Input Over Voltage Protection		265	270	275	V _{RMS}
Output Over Current Protection	Fully electronic against over-load	-	-	110%	I _{OUT_TYP}
Output Over Voltage Protection		-	-	115%	V _{OUT_TYP}
Output Short Circuit Protection	Fully electronic against over-load and continuous short-circuit conditions				
Over Temperature Protection	Automatically resumes operation when the heat sink temperature decreases below 70°C	-	80	-	°C
Surge/Spike Protection	EN 61000-4, EN 61000-5				
Battery	Prevention of battery discharge when charger is off				
	Reverse polarity				

Isolation Characteristics					
Insulation Resistance	Input to Case	-	>100	-	MΩ
Isolation Voltage	Input to Output	-	-	TBD	V
Isolation Voltage	Input to Case	-	-	TBD	V
Isolation Voltage	Output to Case	-	-	TBD	V

Environmental Characteristics					
Operational Temperature	MIL-STD-810G	-32	-	+50	°C
Storage / Transport Temperature	MIL-STD-810G	-40	-	+63	°C
Operational Low Pressure	MIL-STD-810G	-	-	10000	ft
Storage / Transport Low Pressure	MIL-STD-810G	-	-	15000	ft
Salt Fog	MIL-STD-810G	24 hours spray, 24 hours dry, applied 2 times			
Sand and Dust	MIL-STD-810G	<150 µm Dust 150-850 µm Sand			
Fungus	MIL-STD-810G	Analysis of the degree of inertness to fungus growth of the components.			
Solar Radiation	MIL-STD-810G	A2			
Shock	MIL-STD-810G	Sawtooth	20g 11 ms	±X, ±Y, ±Z	
		Half-Sine	10g 11 ms	±X, ±Y, ±Z	
Vibration	MIL-STD-810G	Category 4	Secured Cargo	Truck Transportation and Composite Wheeled Vehicles	
		Category 8	Aircraft	Propeller	
		Category 11	Railroad	Train	
		Category 20	Ground Vehicles	Wheeled and Tracked Vehicles	
		Category 21	Watercraft	Marine Vehicles	
Humidity	MIL-STD-810G	≥ %95 Relative @30°C			
EMI/EMC	MIL-STD-461G	CE102 CS101 CS114 CS115 CS116 CS118 RE102 RS103			
Noise	MIL-STD-1474E	≤ 75 dB at a distance of 1 meter			
Impermeability	Tested by immersion in 1 m water for 30 minutes	IP67			

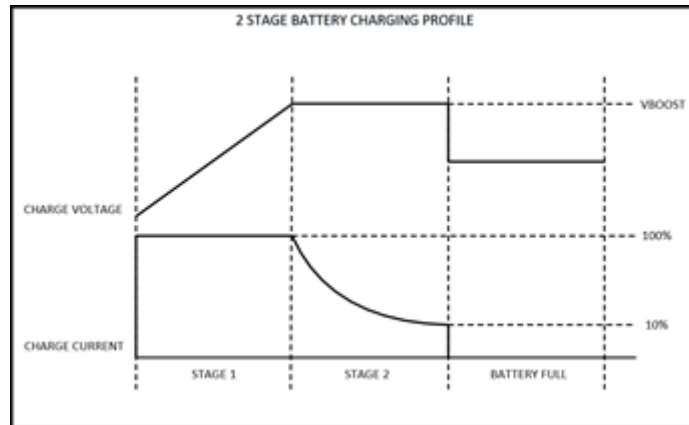

Figure 1. Two stage battery charging profile

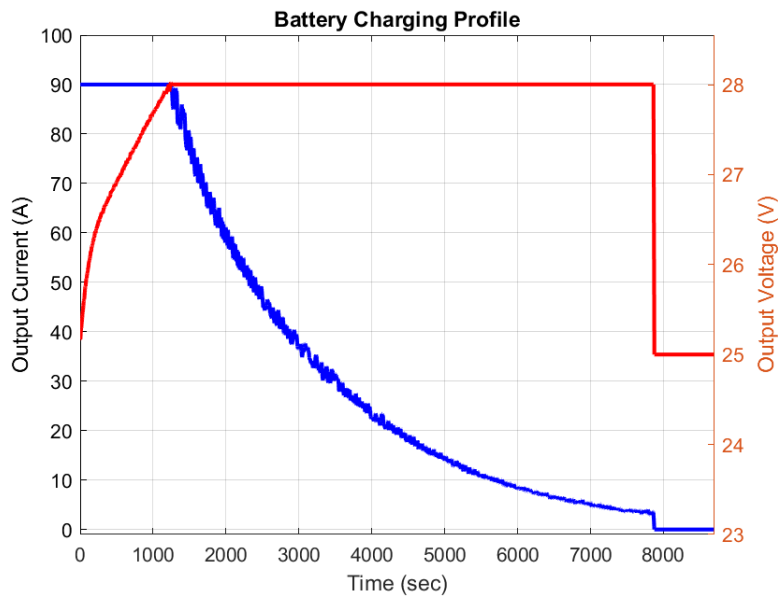

Figure 2. Battery charging profile based on measured battery current and battery voltage data. Maximum power delivered is 2520 W.

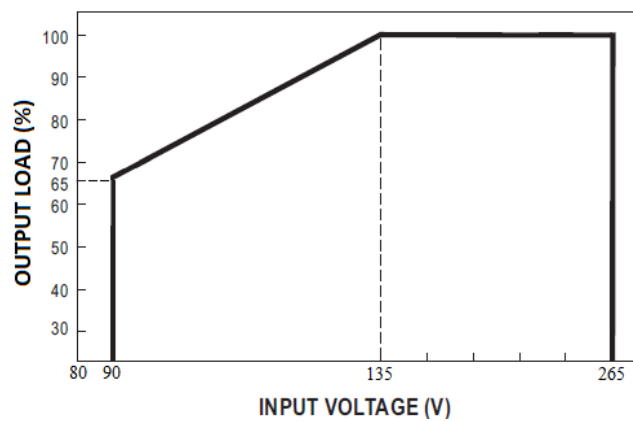
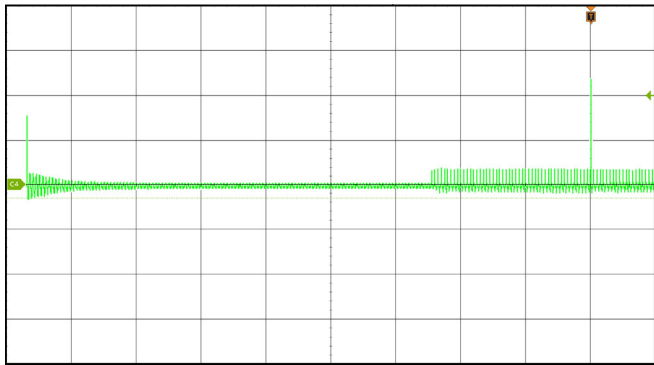
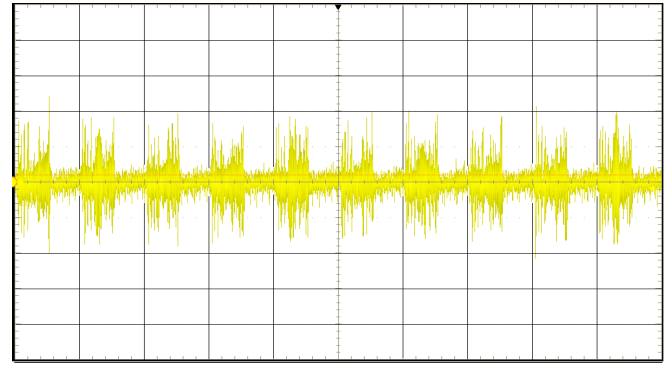

Figure 3. Derating curve of output load versus input voltage



Input current (green) (10 A/div) Time base : 400 ms/div

Figure 4. Inrush current at nominal input voltage



Leakage current (yellow) (10 mA/div) Time base : 20 ms/div

Figure 7. Leakage current at nominal input voltage and 10% load current

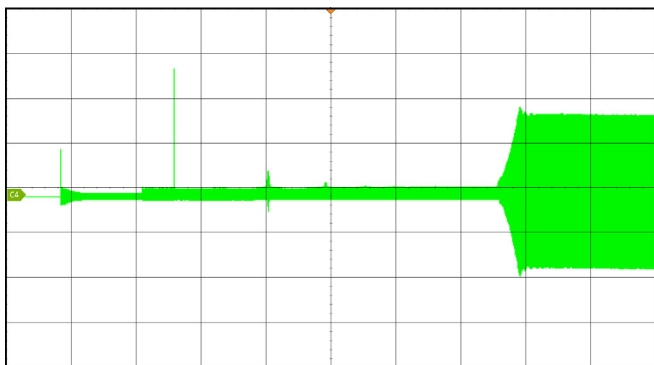

Input current (green) (10 A/div) Time base : 2 s/div

Figure 5. Input current for inrush and start-up stages at nominal input voltage

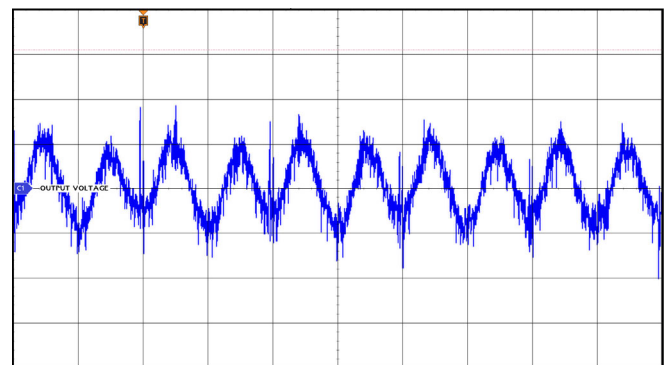

Output voltage (blue) (100 mV/div) Time base : 10 ms/div

Figure 8. Output voltage ripple at nominal input voltage and rated load current (AC Coupled), Bandwidth: 20 MHz

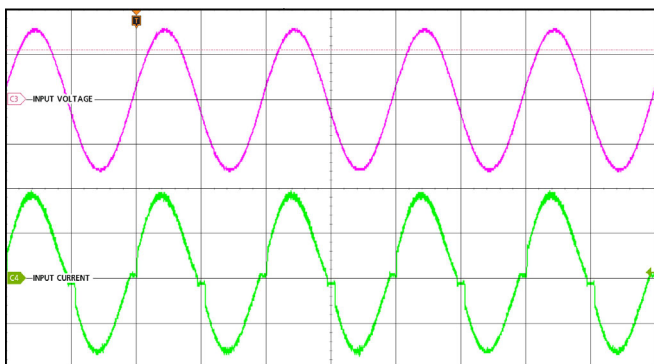

Input voltage (pink) (200 V/div) Time base : 10 ms/div
Input current (green) (10 A/div)

Figure 6. Typical input voltage and current waveforms at rated load current

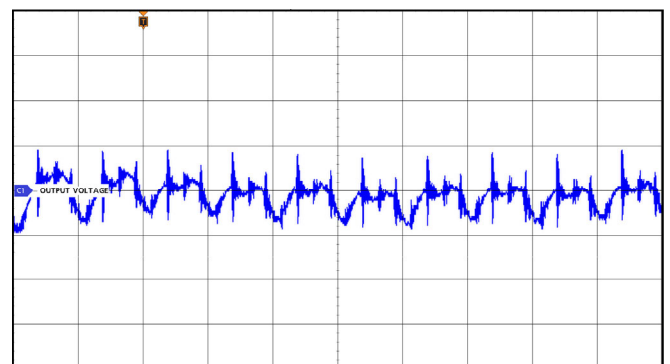

Output voltage (blue) (50 mV/div) Time base : 10 μs/div

Figure 9. Output voltage ripple at nominal input voltage and rated load current (AC Coupled), Bandwidth: 20 MHz

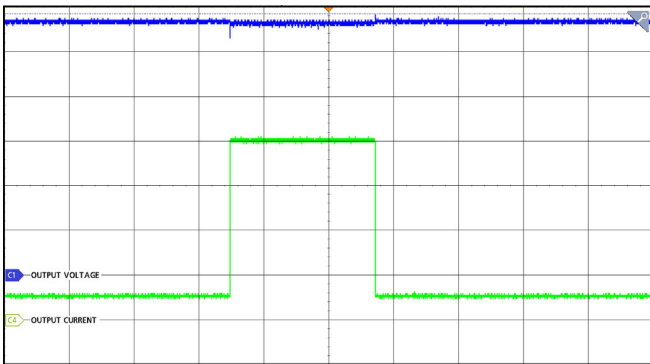

Output voltage (blue) (5 V/div) Time base : 200 ms/div
Output current (green) (20 A/div)

Figure 10. Load transient response: from 10% to 100% and from 100% to 10% at nominal output voltage (DC Coupled)

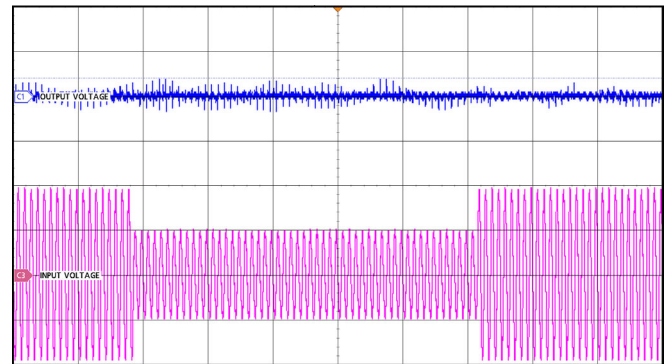

Output voltage (blue) (1 V/div) Time base : 200 ms/div
Input voltage (pink) (200 V/div)

Figure 13. Line transient response: from 265 V_{RMS} to 135 V_{RMS} and from 135 V_{RMS} to 265 V_{RMS} at nominal output voltage (AC Coupled)

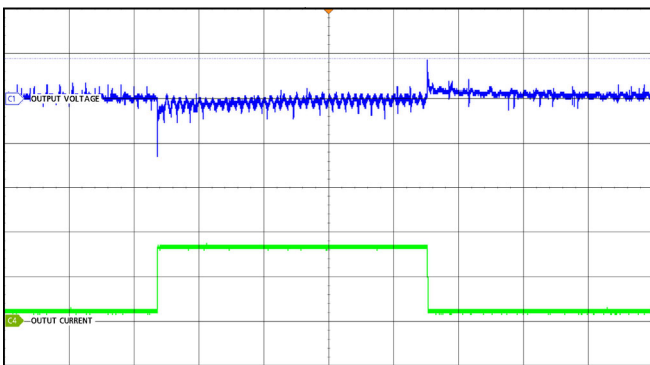

Output voltage (blue) (1 V/div) Time base : 100 ms/div
Output current (green) (50 A/div)

Figure 11. Load transient response: from 10% to 100% and from 100% to 10% at nominal output voltage (AC Coupled)

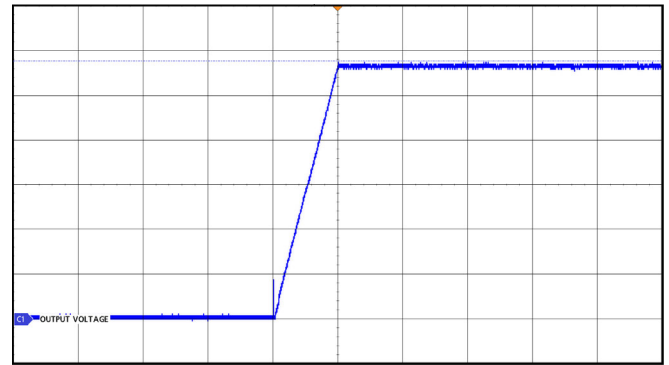

Output voltage (blue) (5 V/div) Time base : 1 s/div

Figure 14. Start-up waveform at rated load current and nominal output voltage

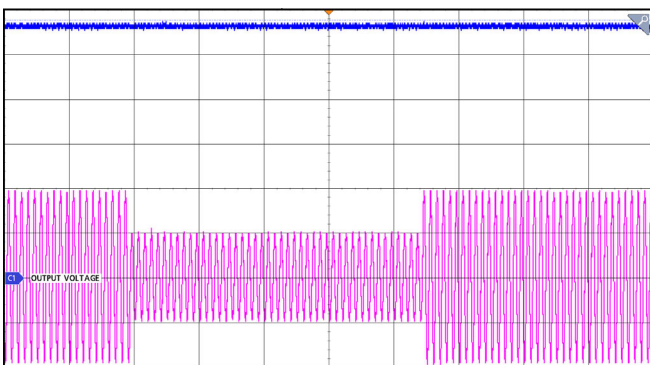

Output voltage (blue) (5 V/div) Time base : 200 ms/div
Input voltage (pink) (200 V/div)

Figure 12. Line transient response: from 265 V_{RMS} to 135 V_{RMS} and from 135 V_{RMS} to 265 V_{RMS} at nominal output voltage (DC Coupled)

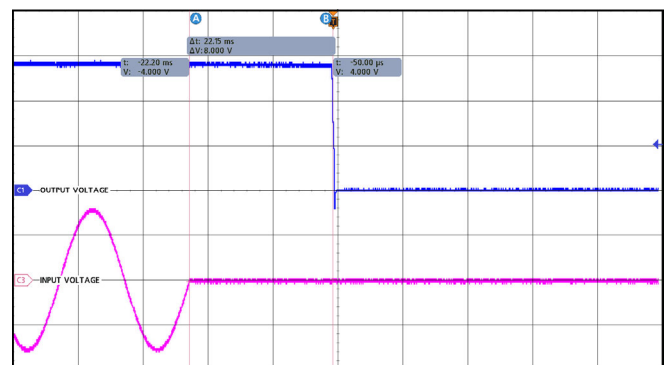

Output voltage (blue) (10 V/div) Time base : 10 ms/div
Input voltage (pink) (200 V/div)

Figure 15. Hold-up waveform at rated load current and nominal output voltage

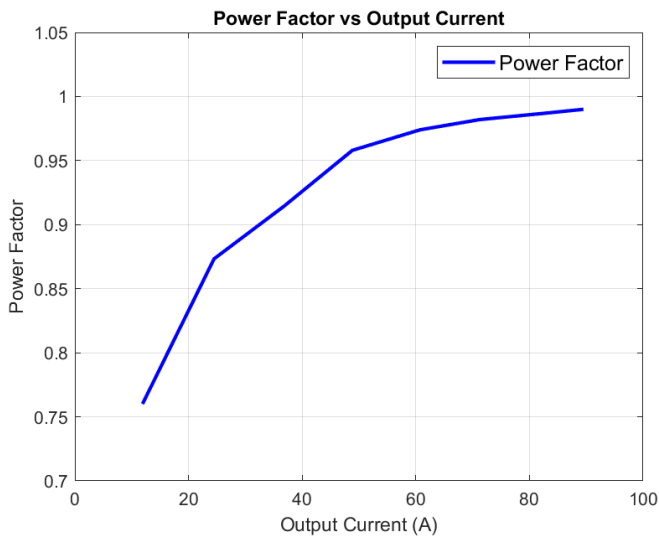

Figure 16. Power factor versus output current at nominal input voltage

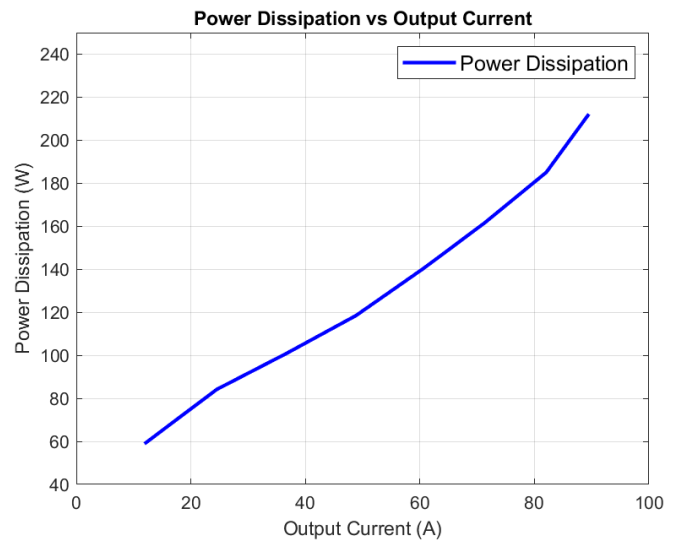

Figure 18. Power dissipation versus output current at nominal input voltage

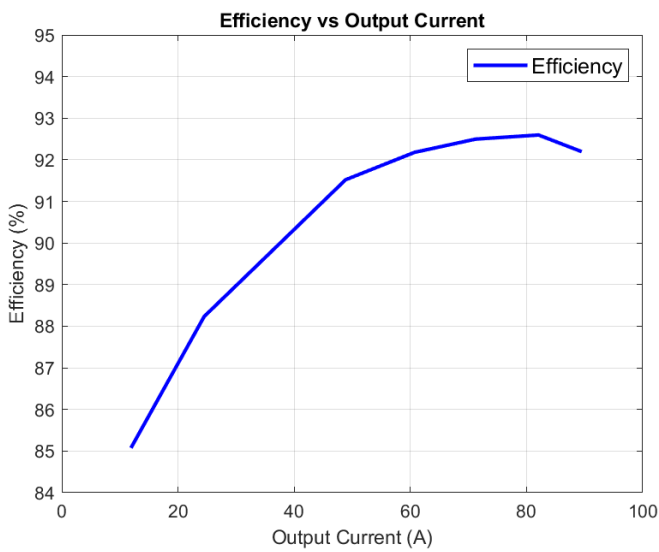

Figure 17. Efficiency versus output current at nominal input voltage

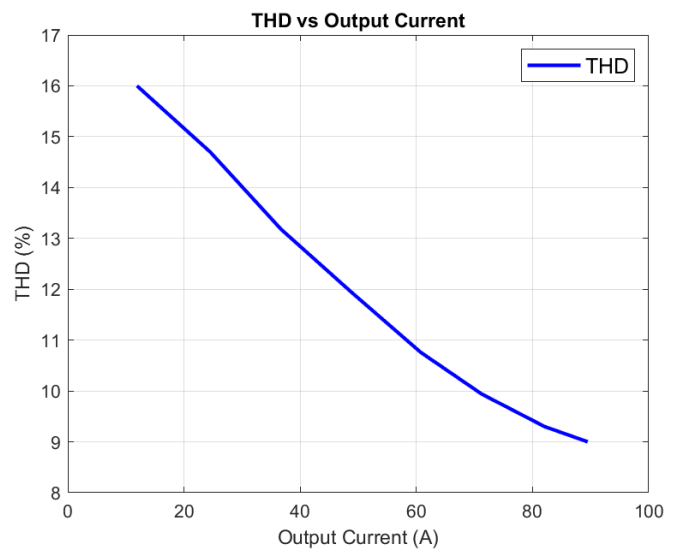
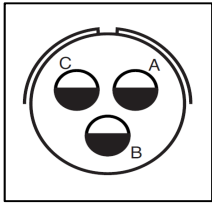

Figure 19. Total harmonic distortion (THD) versus output current at nominal input voltage

Connector Configuration

Input Connector 97B-3102E-16-10P	
Mate Connector 97B-3106F-16-10S	
Pin	Signal
A	PHASE
B	NEUTRAL
C	CHASSIS



Output Connector 97B-3102E-22-22S	
Mate Connector 97B-3106F-22-22P	
Pin	Signal
A	OUT
B	OUT
C	OUT_RTN
D	OUT_RTN

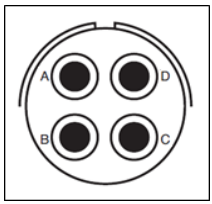

Signal Connector #1 D38999/20WB5SN	
Mate Connector D38999/26WB5PN	
Pin	Signal
A	RS485 Data+
B	RS485 Data-
C	RS485_RTN
D	ID_SET
E	ID_SET_RTN

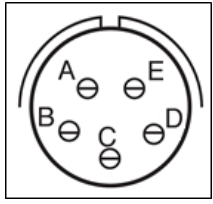

Signal Connector #2 D38999/20WB5SA	
Mate Connector D38999/26WB5PA	
Pin	Signal
A	RS485 Data+
B	RS485 Data-
C	RS485_RTN
D	CS Data+
E	CS Data-

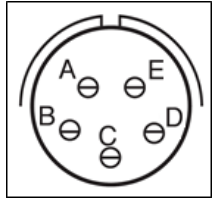

Led Configuration



Figure 20. Front Panel

Placement	Definition	Description	Status
	Input	AC Input Active	GREEN
		AC Input Passive	OFF
		AC Input Fault	RED
	Output	DC Output Active	GREEN
		DC Output Passive	OFF
	Fault	Device Fault	RED
Device OK		OFF	

Mechanical Drawings

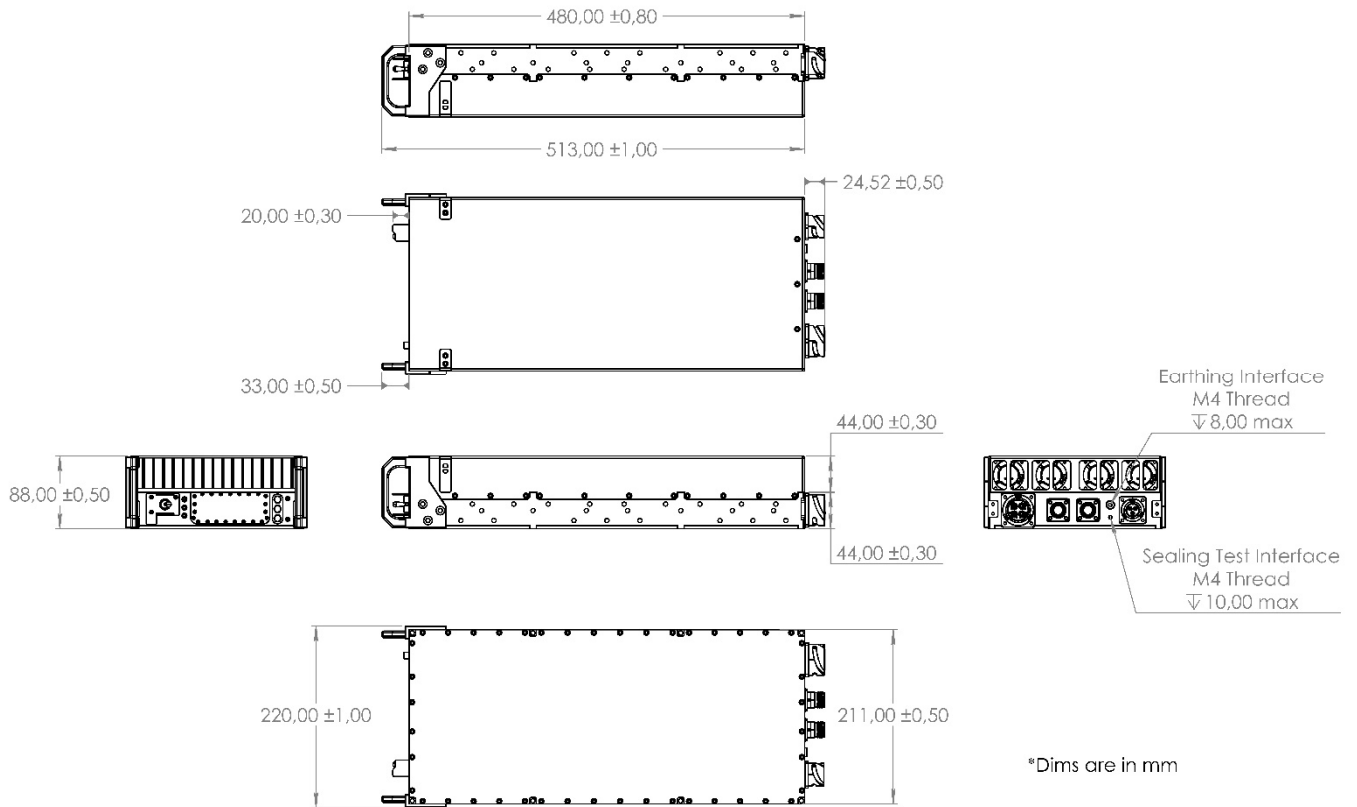
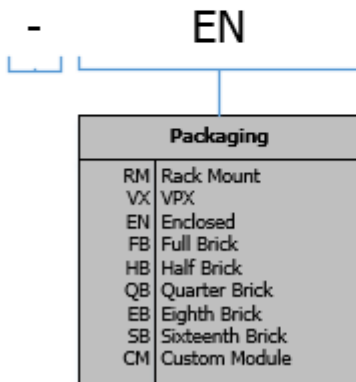
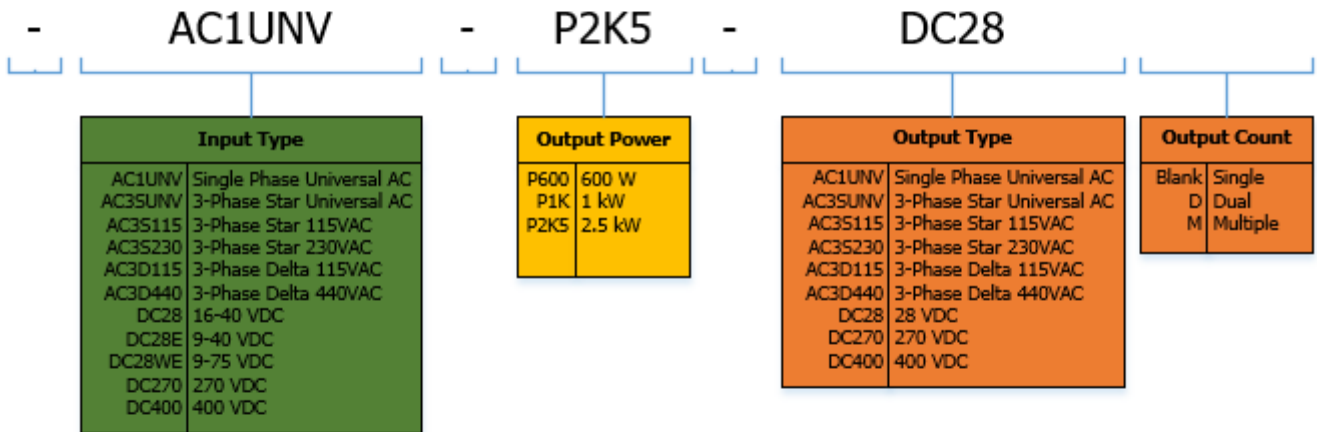
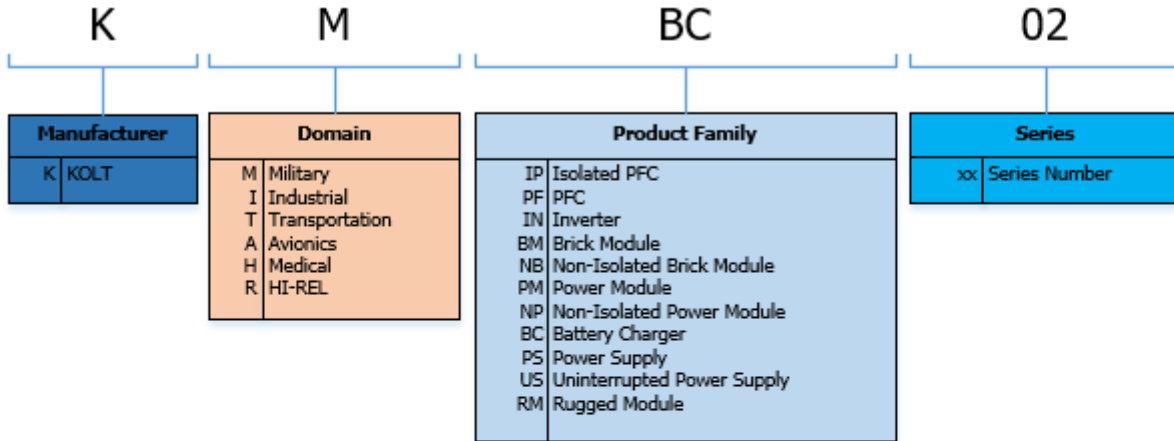

Figure 21. Mechanical Dimensions

Material Finish	Sealed Aluminum Alloy 6061-T6 Case Color Options: 37030, 34094
------------------------	---

Part Ordering Information

Manufacturer	Manufacturer Part Number
KOLT	KMBC02-AC1UNV-P2K5-DC28-EN



Not all combinations make valid part numbers, please contact KOLT for availability.

Revision History

Revision	Date	Description	Page Number(s)
A-PC1	09.08.2021	Initial Release	-
A-PC2	22.12.2021	Second Release	-
A-PC3	25.02.2022	Third Release	-
A-PC4	14.03.2022	Fourth Release	-
A-PC5	21.03.2022	Fifth Release	-
A-PC6	25.03.2022	Sixth Release	-
A-PC7	01.04.2022	Seventh Release	-
A-PC8	18.04.2022	Eighth Release	-
A-PC9	16.09.2022	Ninth Release	-